

JBL

AM5212/66 2-Way Loudspeaker System with 1 x 12" LF

Professional Series

Key Features:

- ▶ 60° x 60° Coverage
- ▶ 262H-1 Differential Drive® Low-Frequency Driver
- ▶ 2408H-1 High-Frequency Compression Driver
- ▶ Large PT™ Progressive Transition waveguide for excellent pattern control and low distortion
- ▶ Rotatable waveguide for vertical or horizontal orientation
- ▶ Bi-Amp/Passive Switchable
- ▶ Available in Black, White and WRC/WRX weather resistant finishes

Applications:

- ▶ Performing Arts Facilities
- ▶ Theatrical Sound Design
- ▶ Auditoriums
- ▶ Worship Facilities
- ▶ Live Clubs
- ▶ Dance Clubs
- ▶ Sports Facilities
- ▶ Themed Entertainment Venues

The AM5212/66 is a medium power, lightweight, 2-way, full-range loudspeaker system comprised of the JBL Differential Drive dual voice coil and dual magnetic gap 262H-1 300 mm (12 in) low frequency driver and 2408H-1 high-frequency 38 mm (1.5 in) exit, 38 mm (1.5 in) voice-coil compression driver. The large format Progressive Transition waveguide provides excellent 60° x 60° coverage. The waveguide is rotatable so the loudspeaker system can be used in either the vertical or horizontal orientation. High-slope passive networks minimize band overlap. Well-controlled off-axis response enhances arrayability.

The enclosure is constructed of multiply birch coated in JBL's rugged DuraFlex™ finish and is heavily braced to maximize low-frequency performance. The trapezoid enclosure is fitted with fifteen M10 threaded attachment points and utilizes a 14-gauge steel grille internally lined with acoustically transparent foam to provide additional driver protection and give a very professional appearance.

The AM5212/66 is part of JBL's AE Series, a versatile family of loudspeakers intended for a wide variety of applications.



Specifications:

System:	
Frequency Range ¹ (-10 dB):	37 Hz – 20 kHz
Frequency Response ¹ (±3 dB):	43 Hz – 20 kHz
Coverage Pattern:	60° x 60°, rotatable waveguide
Directivity Factor (Q):	13.4
Directivity Index (DI):	11.3 dB
Crossover Modes:	Bi-amp/Passive switchable
Passive Crossover Frequency:	2 kHz
Transducer Power Rating (AES) ² :	LF: 400 W (1600 W peak), 2 hrs 300 W (1200 W peak), 100 hrs HF: 40 W (160 W peak), 2 hrs
Long-Term System Power Rating (IEC) ³ :	Passive mode: 300 W (1200 W peak), 100 hrs
Maximum SPL:	Bi-amp mode: LF: 122 dB-SPL cont avg (128 dB peak) HF: 130 dB-SPL cont avg (136 dB peak) Passive mode: 121 dB-SPL cont avg (127 dB peak)
System Sensitivity (1W @ 1m) ⁴ :	Passive mode: 96 dB SPL
Transducers:	
Low Frequency Driver:	1 x JBL 262H-1 300 mm (12 in) driver with 50.8 mm (2 in) dual voice coil
Nominal Impedance:	8 ohms
Sensitivity (1W @ 1m, within operational band):	97 dB SPL
High Frequency Driver:	JBL 2408H-1, 38 mm (1.5 in) exit compression driver, 38 mm (1.5 in) voice coil
Nominal Impedance:	8 ohms
Sensitivity (1W @ 1m):	114 dB SPL
Waveguide:	PT-H66HF-1
Physical:	
Enclosure:	Trapezoidal with 15 degree side angles, 16 mm (5/8 in) exterior grade 11-ply birch plywood
Suspension Attachment:	15 points (4 top, 4 bottom, 2 each side, 3 rear), M10 threaded hardware
Finish:	Black DuraFlex™ finish. White available upon request.
Grille:	Powder coated 14 gauge perforated steel, with acoustically transparent black foam backing.
Input Connector:	NL4 Neutrik Speakon® and CE-compliant covered barrier strip terminals. Barrier terminals accept up to 5.2 sq mm (10 AWG) wire or max width 9 mm (.375 in) spade lugs. Speakon in parallel with barrier strip for loop-through.
Environmental Specifications:	Mil-Std 810; IP-x3 per IEC529.
Dimensions (H x W x D in vertical cabinet orientation):	711 x 369 x 458 mm (28.0 x 14.5 x 18.0 in)
Net Weight:	20.2 kg (45 lb)
Optional Accessories:	M10 x 35 mm forged shoulder eyebolts with washers U-Bracket MTU-3

¹Bi-amp mode, with recommended active tuning, 2π half-space.

²AES standard, one decade pink noise with 6 dB crest factor within device's operational band, free air. Standard AES 2 hr rating plus long-term 100 hr rating are specified for low-frequency transducers.

³IEC standard, bandwidth pink noise with 6 dB crest factor, 100 hours.

⁴Calculated based on power rating and sensitivity, exclusive of power compression.

⁵Anechoic sensitivity in free field, no additional sensitivity gain from boundary loading.

JBL continually engages in research related to product improvement. Changes introduced into existing products without notice are an expression of that philosophy.

▶ AM5212/66 2-Way Loudspeaker System with 1 x 12" LF

Beamwidth

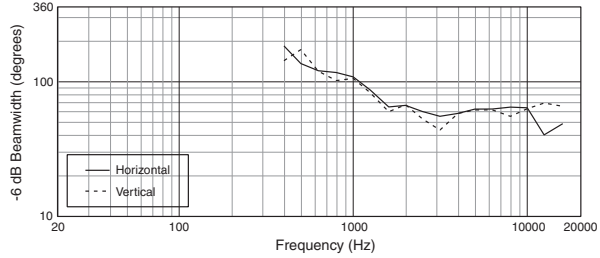

Frequency Response and Impedance

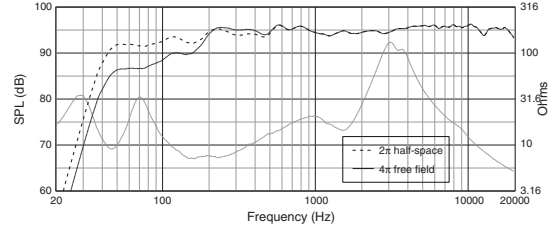

Directivity Index, Q

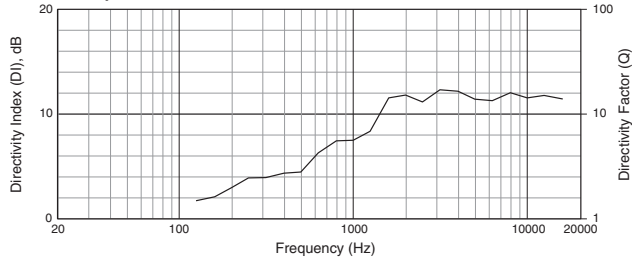

Horizontal Off-Axis Frequency Response

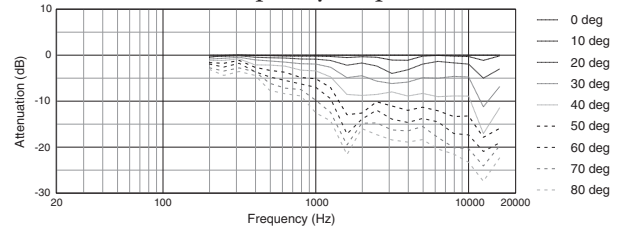

Vertical Up Off-Axis Frequency Response

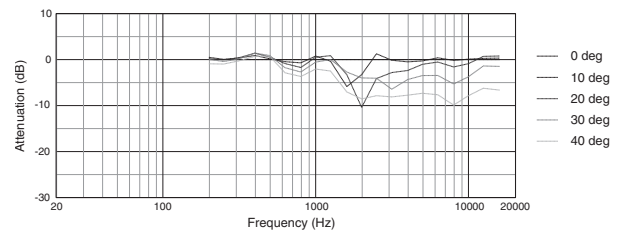

Dimensions

Dimensions in mm (in)

For more detailed dimensional information, refer to Application Data Sheet

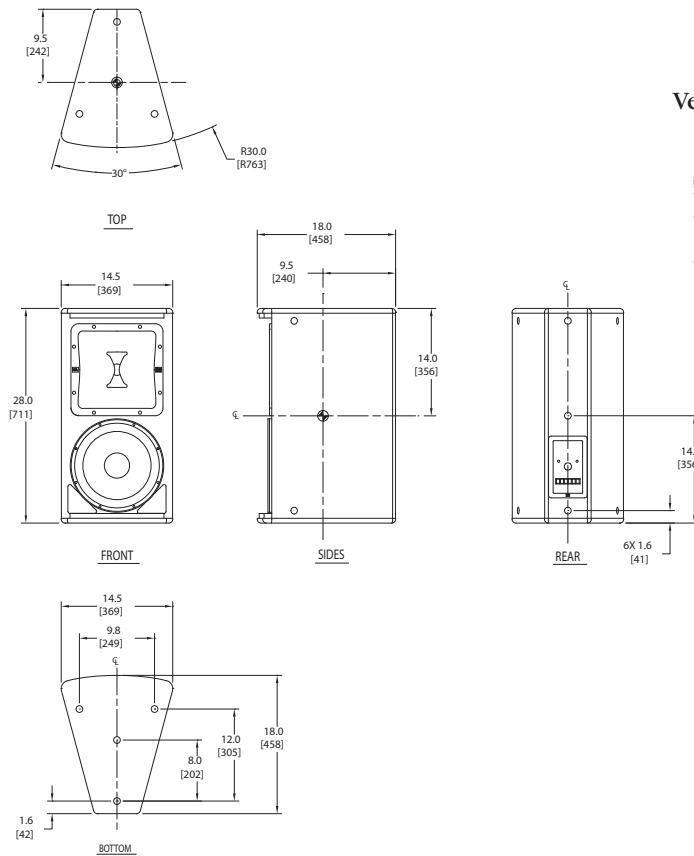

Vertical Down Off-Axis Frequency Response

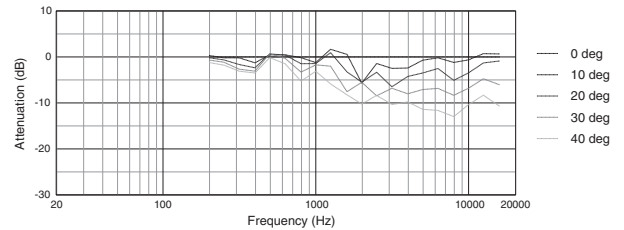

Measurements obtained in full passive crossover mode with no signal processing. Graphs are from unaltered measured data.

Horizontal 1/3 Octave Polar Response

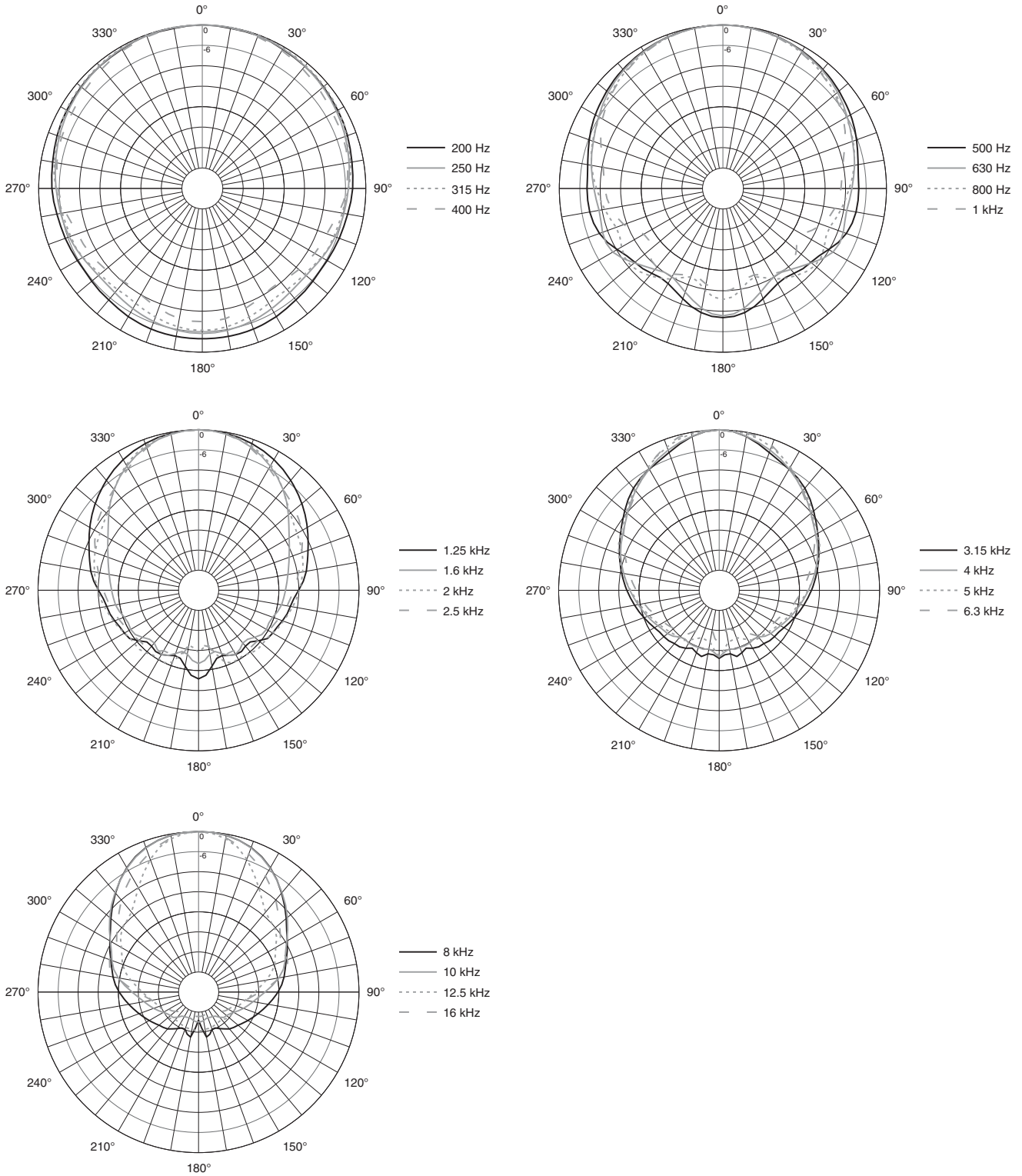

▶ AM5212/66 2-Way Loudspeaker System with 1 x 12" LF

Vertical 1/3 Octave Polar Response

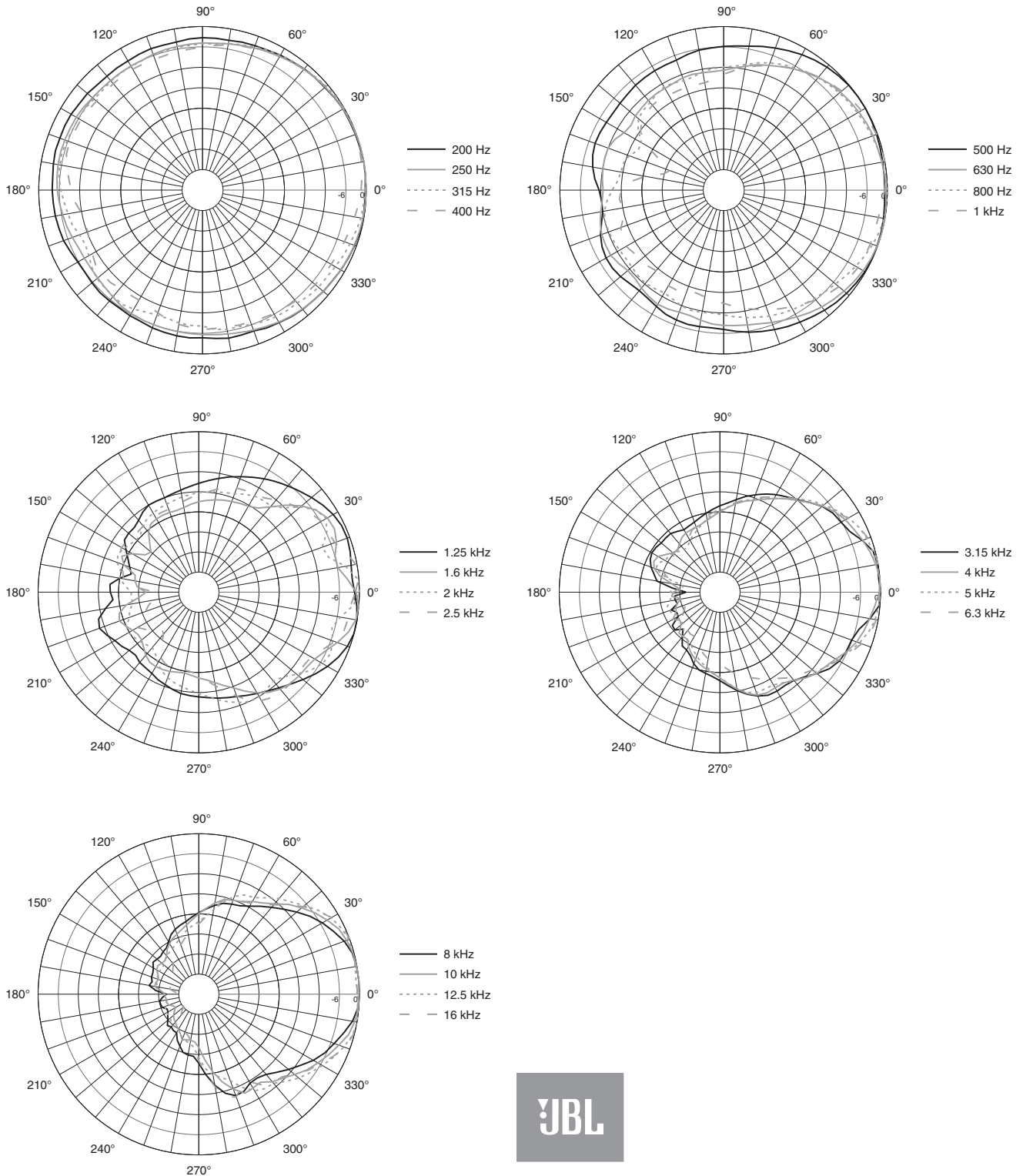

JBL Professional
 8500 Balboa Boulevard, P.O. Box 2200
 Northridge, California 91329 U.S.A.

Harman International
 © Copyright 2010 JBL Professional
www.jblpro.com

SSAM5212/66
 CRP
 01/10