

Key Features:

- ▶ Robust 15mm enclosure with black textured finish
- ▶ 304.8 mm (12 in) LF transducer
- ▶ 90° x 90° Waveguide with a 25 mm (1 in) exit 38mm (1.5") diaphragm compression driver
- ▶ Dual Neutrik NL4 connectors plus screw terminals
- ▶ Multiple attachment points for ultimate flexibility

Applications:

- ▶ Performing Spaces
- ▶ Clubs & Bars
- ▶ Houses of Worship
- ▶ Multi Media Spaces
- ▶ Retail & Hospitality Spaces
- ▶ Presentation Suites
- ▶ Educational Facilities

AC299 is a compact 2-way full-range loudspeaker system comprised of one 304.8 mm (12 in) low frequency driver and one 25 mm (1 in) exit/38 mm (1.5 in) voice-coil compression driver. The horn provides 90° by 90° coverage in vertical and horizontal orientation. High-slope passive crossovers minimize band overlap and well-controlled offaxis response.

The cabinet is fitted with M10 threaded suspension points. Four threaded inserts located on back of the enclosure allow attachment of a MultiMount® or similar type mounting.

AC299 is part of JBL's AE Application Engineered Series, a versatile family of loudspeakers for a wide variety of fixed installation applications.



Specifications:

System:	
Frequency Range (-10 dB) ¹ :	63 Hz - 20 kHz
Frequency Response (±3 dB) ¹ :	80 Hz - 18kHz
System Sensitivity (1w @ 1m) ¹ :	97 dB
Nominal Impedance:	8 ohms
Maximum SPL(1m) ² :	121 dB (127 dB peak)
Power Rating ³ : (Continuous/Program/Peak)	250 W/500 W/1000 W
Coverage Pattern:	90° x 90° (H x V)
Crossover:	1.5 kHz
Transducers:	
Low frequency driver:	1 x 12" woofer (P/N: 5050730), 304.8 mm (12 in) driver with 38 mm (1.5 in) voice-coil
High frequency driver:	1 x 2408H-2 driver with 25 mm (1 in) exit/38 mm (1.5 in) voice-coil
Physical:	
Input Connector:	Dual Neutrik NL4MP connectors plus covered barrier trip terminals
Enclosure:	15 mm multi-ply hardwood plywood
Grille:	Powder coated, 1.5mm perforated steel, with acoustically transparent black foam backing
Finish:	Textured black paint finish. White (-WH) available upon request. Not available with WRC & WRX finish.
Suspension / Mounting:	14 x M10 and 4 x M10 for Wall Mount Bracket. Optional U-bracket, L-bracket and wall-mount bracket
Dimensions (H x W x D):	600 mm x 370 mm x 392 mm 23.6 in x 14.5 in x 15.4 in
Net Weight:	17.3 kg (38.1lbs)

1 Full space (4π) conditions

2 Calculated maximum SPL based on rated power handling

3. IEC shaped pink noise with 6dB CF for 100hrs

JBL continually engages in research related to product improvement. Some materials, production methods and design refinements are introduced into existing products without notice as a routine expression of that philosophy. For this reason, any current JBL product may differ in some respect from its published description, but will always equal or exceed the original design specifications unless otherwise stated.

▶ AC299 2-Way Loudspeaker with 1 x 12" LF

Beamwidth

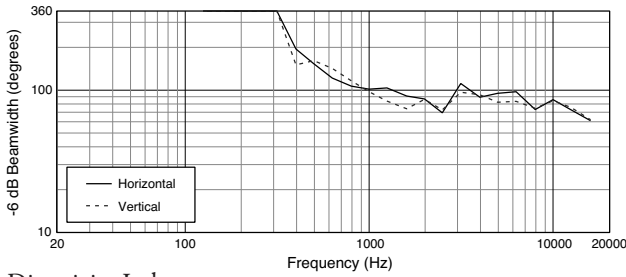

Horizontal Left Off-Axis Frequency Response

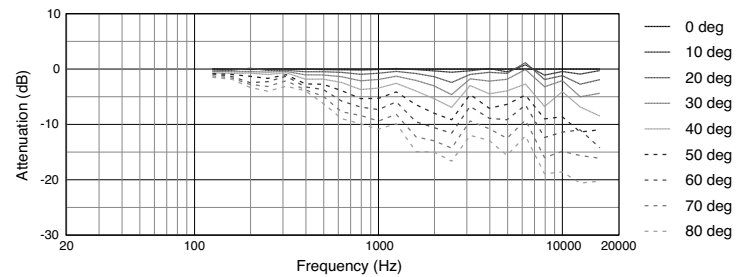

Directivity Index

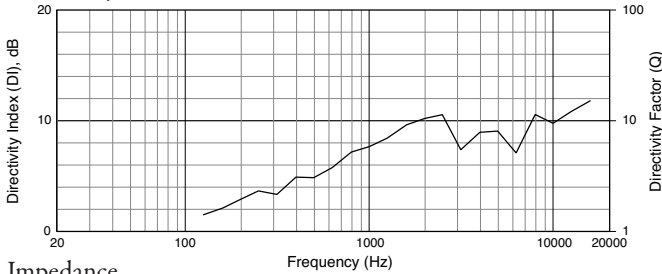

Horizontal Right Off-Axis Frequency Response

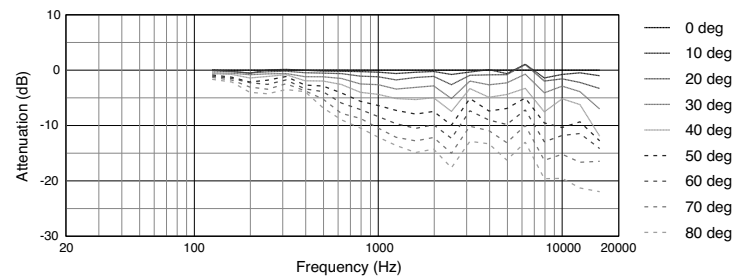

Impedance

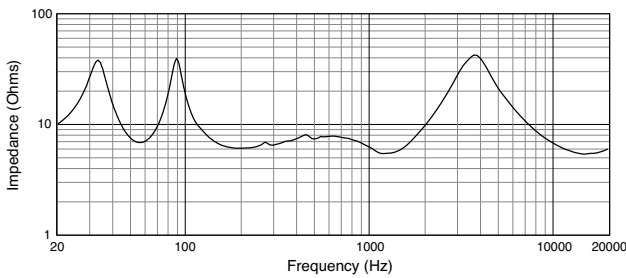

Vertical Up Off-Axis Frequency Response

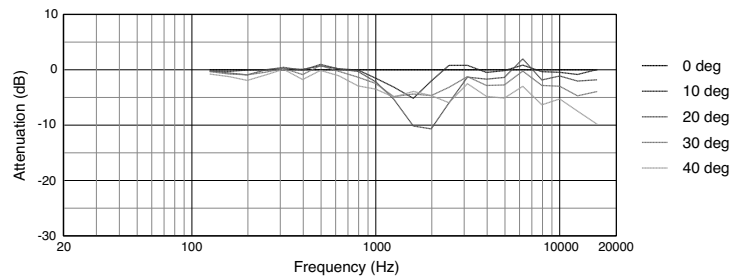

Frequency Response, 1W/1M

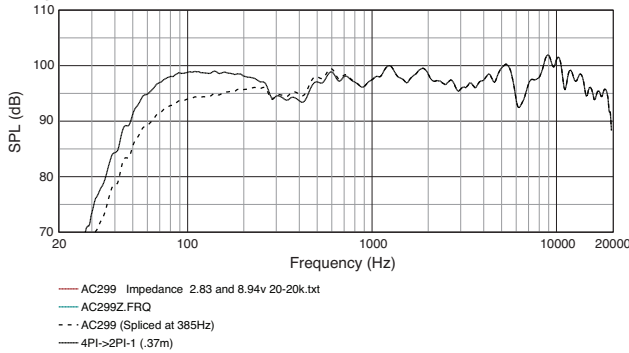

Vertical Down Off-Axis Frequency Response

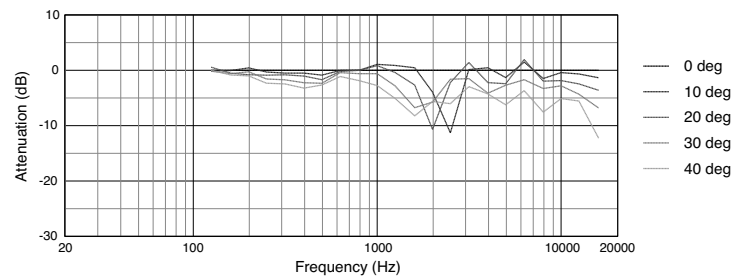

Dimensions:

Dimensions in mm (inch)

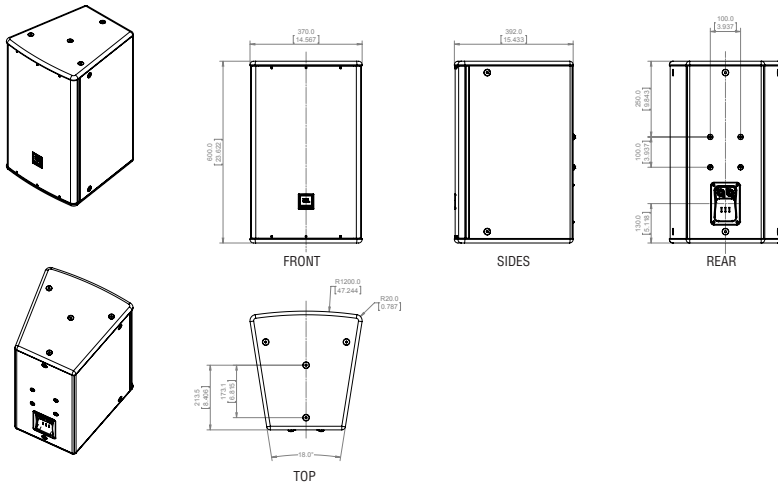

JBL Professional
8500 Balboa Boulevard, P.O. Box 2200
Northridge, California 91329 U.S.A.

© Copyright 2015 JBL Professional
www.jblpro.com

AC299
SZ
01/15